

PRODUCT MODEL NUMBERS

WFW9400V

Electrical: 120-volt, 60-Hz, AC-only, 15- or 20-amp electrical supply. A time-delay fuse or circuit breaker is recommended. It is recommended that a separate circuit serving only this appliance be provided.

PRODUCT DIMENSIONS

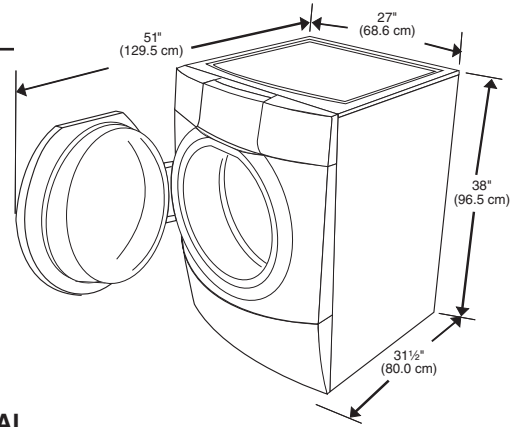

RECESSED AREA AND CLOSET INSTALLATIONS, WITH OR WITHOUT PEDESTAL

The dimensions shown are for the recommended spacing.

Recessed Area or Closet Installation

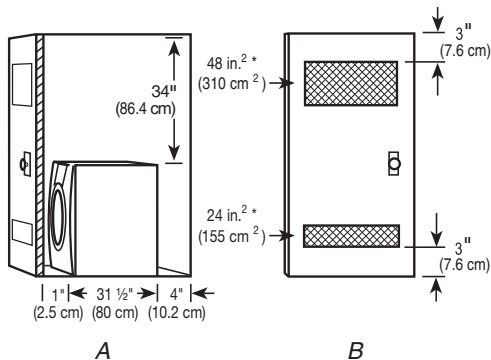

A. Side view - closet or confined area
B. Closet door with vents

*Minimum top and bottom opening for closet door.

Recessed Area or Closet Installation — Washer on Pedestal

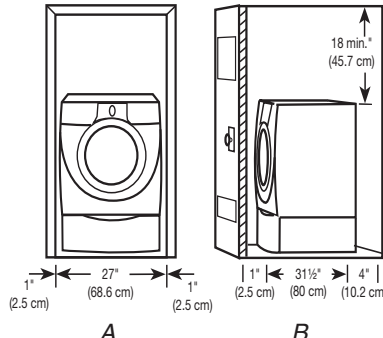

A. Recessed area
B. Side view — closet or confined area

Recommended installation spacing for cabinet installation

For cabinet installation, with a door, the minimum ventilation openings in the top are required.

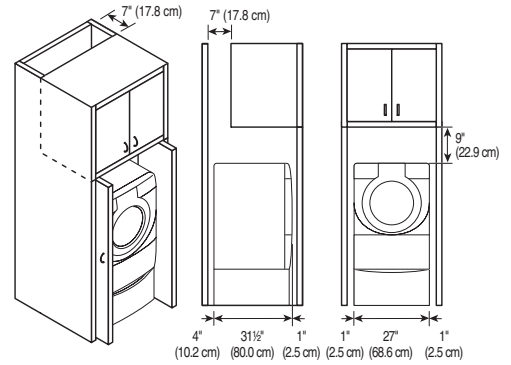

UNDERCOUNTER INSTALLATION

Dimensions shown are for minimum spacing.

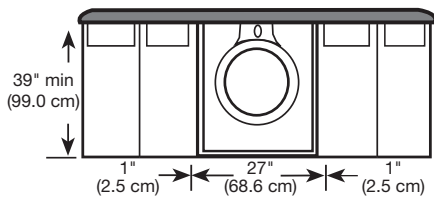

Stacked Washer and Dryer

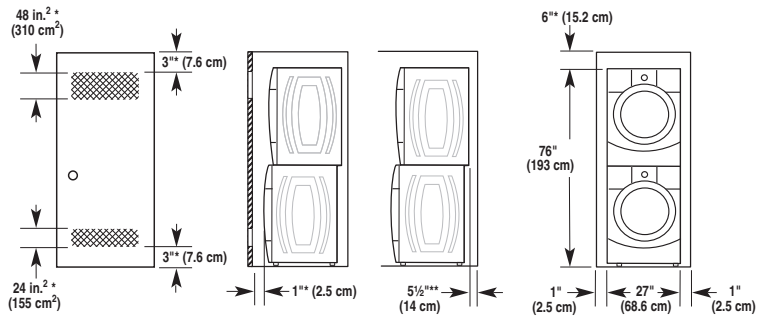

*Required spacing
**For venting out the side, 1" (2.5 cm) spacing is allowed.

DRAIN SYSTEM OPTIONS

Standpipe drain system - wall or floor (view A & B)

The standpipe drain requires a minimum diameter standpipe of 2" (5 cm). The minimum carry-away capacity can be no less than 17 gal. (64 L) per minute. The top of the standpipe must be at least 30" (76.2 cm) high and no higher than 96" (2.4 m) from the bottom of the washer.

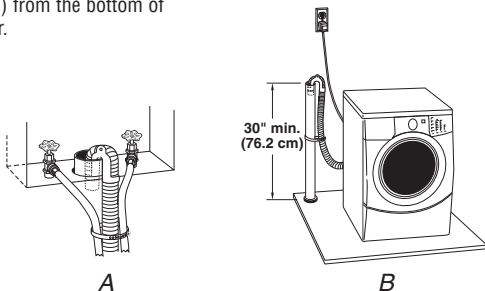

Laundry tub drain system (view C)

The laundry tub needs a minimum 20 gal. (76 L) capacity. The top of the laundry tub must be at least 30" (76.2 cm) above the floor.

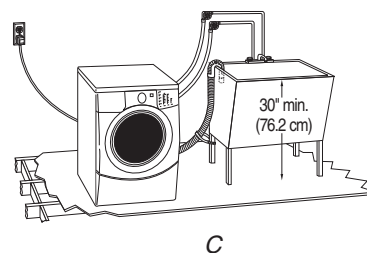

Floor drain system (view D)

The floor drain system requires a siphon break that may be purchased separately. The siphon break must be a minimum of 28" (71 cm) from the bottom of the washer. Additional hoses might be needed.

